

# Owner's Manual & Safety Instructions

## BATTERY OPERATED LIQUID TRANSFER PUMP

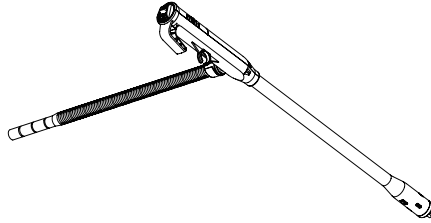

**KTEP01USB**

Save this manual for the safety warnings and precautions, assembly, operating, inspection, maintenance and cleaning procedures.

### **DANGER**

This is the safety alert symbol. It is used to alert you to potential personal injury hazards. Obey all safety messages that follow this symbol to avoid possible injury or death.

### **WARNING**

Indicates a hazardous situation which, if not avoided, could result in death or serious injury.

### **CAUTION**

Indicates a hazardous situation which, if not avoided, could result in minor or moderate injury.

### **NOTICE**

Addresses practices not related to personal injury.

# Specifications:

<b>Power</b>	Requires 4 "AA" Batteries (NOT Included); Use TYPE-C data cable to connect portable power supply with USB port or charger with USB port
<b>Delivery Volume</b>	12 Liters per Minute (3.2GPM)
<b>Auto - Stop</b>	No
<b>Applications</b>	Gasoline, diesel, kerosene, light oils Non-potable water

## IMPORTANT SAFETY INFORMATION

**⚠ WARNING** Read all safety warnings and instructions. Failure to follow the warnings and instructions may result in serious injury. Save all warnings and instructions for future reference.

1. Do not pump the corrosive liquids and drinking water.
2. When pumping gasoline and flammable liquids, be alert to possible explosion hazard. Flammable fluid fumes and gasoline vapors can be an explosive hazard. Avoid sparks and use only with adequate ventilation.
3. Wear ANSI-approved safety goggles and heavy-duty, chemical resistant work gloves during use.
4. This product is not a toy. Do not allow children to play with or near this item.
5. Use as intended only. Only the use pump for transferring gasoline, water, oil, and other non-corrosive liquids.
6. Do not operate the pump if it is hot.
7. Verify that all connections are tight before use to eliminate leaking.
8. Do not pump used, dirty oil.
9. Do not use near open flame or heat sources.
10. Do not turn the pump upside down after use.
11. Remove batteries when not in use.
12. Know and obey city and state laws for proper disposal of oil and gasoline. Dispose of properly in accordance with all local laws and regulations.
13. Follow all guidelines regarding materials being pumped, including SDS instructions and EPA regulations.
14. Do not mix old and new batteries. Do not mix alkaline, standard (carbon-zinc), or rechargeable (nickel-cadmium) batteries. Position batteries in proper polarity. Do not use swollen or leaking batteries.
15. Do not operate when tired or when under the influence of drugs or medication.
16. Inspect the pump before every use; do not operate if parts are damaged or loose.
17. Maintain product labels and nameplates. These are very important.

# SAVE THESE INSTRUCTIONS.

## Operating Instructions

Read the ENTIRE WARNING section at the beginning of this manual including all text under subheadings therein before set up or use of this product.

### HOW TO PLACE THE BATTERIES

Insert 4 AA batteries according to + and – signs

Direction of batteries as indicated in below picture

- \* Replace all 4 batteries at the same time
- \* Use the same brand/type of batteries

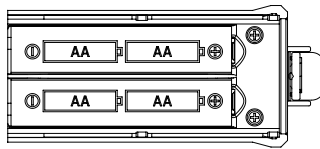

### HOW TO USE DC POWER

Plug the Type C end into the input end of the pump body, and plug the USB end into the input power supply (either an AC to DC adapter or a power bank).

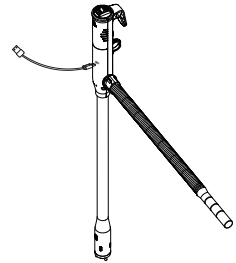

## Note:

**The input power supply must be DC5V,>2A otherwise the pump will not start or work unstable.**

### How To Open The Battery Cover

Push the battery cover upward in the direction of the arrow, see below Fig. Open the battery cover again.



## EMERGENCY CASE WHEN ALL (4) BATTERIES ARE NOT AVAILABLE

It is recommended to use all 4 AA batteries when you are able, but it is possible to operate with 2 AA batteries during emergencies.

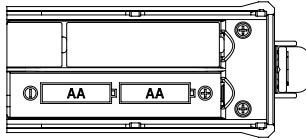

## WHEN TO REPLACE THE BATTERIES

- Motor does not operate, even after pressing ON switch or transfer rate becomes slower than in normal operation.
- Batteries can begin to discharge if they are stored for a long period of time. Check the expiration dates of batteries.

## Operation :

1. Insert the intake tube as far as possible into the liquid to be transferred.
2. Place the discharge hose into a container (not included) in which to pump the liquid.  
Do not place receiving container higher than the battery housing.
3. Turn the ON/OFF Switch to ON. Make sure the battery compartment remains sealed during operation.

## NOTICE:

**Do not run unit dry.**

**Make sure intake tube is fully submerged in liquid before turning on.**

4. When the transfer is complete, turn the switch OFF. After use, do not turn pump upside down.
5. Rinse unit with water and wipe dry. Remove batteries and store in a clean, dry location out of reach of children.

## HOW TO USE

1. Start the pump by pressing button "ON".

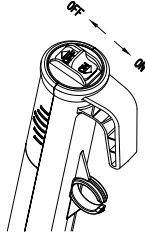

2. After pressing the OFF button to manually stop pumping the liquid, lift the discharge hose above the tank to drain any excess fuel or liquid back into the supply tank.

Operate as the bellow pics shown.



Manual series

3. Put the discharge nozzle into the discharge compartment and lock it into place with the clip.

**⚠** \* After fueling, place the discharge hose into the discharge nozzle holder. In the event the fuel tank falls and the discharge hose is not in the nozzle holder, the liquid can leak out.

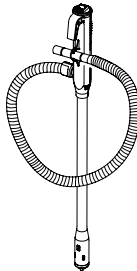

Manual series

## Parts List :

### KTEP01USB Series

1	Motor inside
2	Intake Pipe
3	Control Box Body
4	Power Input Port
5	Battery Case Cover
6	ON &OFF Button
7	Handle
8	Clip For Nozzle
9	Joint Nut
10	Discharge Hose
11	Discharge Nozzle

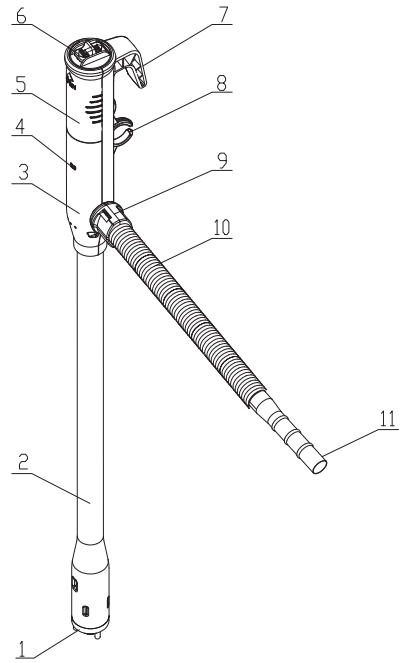

## HOW TO STORE

- If the pump will not be used for an extended period, remove it from the tank and drain all fuel, ensuring no fuel remains in the hose. Then, wipe down the pump with a cloth before storing it.
- Make sure to take the batteries out before storing the pump.
- Do not store the pump in enclosed airtight container.

## Maintenance

### SAFETY INSTRUCTIONS

#### NOT FOR DRINKING WATER

#### DO NOT DO THIS :

- Do not transfer fuel while the vehicle or it's heater is ON, as this may cause a fire.
- Do not leave the pump unattended (may cause oversupply of oil, a fire or any accident).
- Do not alter or disassemble the pump (may cause failure of the product or an accident).
- Do not place the pump in a wet area (may cause failure of the product or an accident).
- Do not use deteriorated or aged fuels (May cause the product to fail).
- Do not use for drinkable liquids, Thinners, Solvents, Hot liquids, Aceton, Benzene, Creosol, Ethyl, Phenol, Methyl, Ethanol Concentration, Caustic Soda, Nitric acid, Hydrochloric acid, Sulfuric acid, etc.
- Do not shock the pump (may cause a failure or damage of the product).
- Do not run the pump 'dry' or let the pump idle without transferring (may cause failure of product)
- Do not place the product in a vehicle with all windows closed, in direct sunlight, or near heating appliances, as this may cause damage or create a safety hazard.
- Do not allow children to operate the product without adult supervision.
- Do not use the product on carpet, wood floor or combustible area (may cause a fire). Be careful not to damage the floor surface and or carpet by fuel leakage.
- Do not store the pump in enclosed airtight container.

## YOU MUST DO THIS

### WARNING:

#### IMPROPER USE CAN CAUSE A DEATH OR SERIOUS INJURY

**! Make sure to use the pump on even surface(If the tank falls down during the liquid supply, liquid will leak and may cause a fire an accident)**

**! Make sure the pump is tightly secured to the tank before turning the pump on.**

**! Make sure remove any left-over fuel in the pump after each use (may cause of failure of the pump if fuel remains around the sensor).**

**! Make sure to detach the tank from the pump when moving(may cause leak of fuel if moved while the tank is attached).**

# Troubleshooting

FAULTS	CHECKS (possible causes)	REMEDIES
The pump does not operate even after pressing ON	<p>A: Batteries may be incorrectly placed.</p> <p>B: Batteries are dead.</p> <p>C: Ensure the impeller cap is fitted correctly.</p> <p>D: Check the battery polarity.</p> <p>E: Check to see if the impeller is stuck.</p> <p>F: Battery Terminals are rusted.</p> <p>G: USB is in poor contact.</p> <p>H: Ensure the power supply is 5V, 2A.</p>	<p>A: Ensure the batteries are placed in the pump correctly.</p> <p>B: Replace the batteries with a new, fully charged set.</p> <p>C: Re-apply the impeller cap.</p> <p>D: Ensure the batteries are inserted correctly and have charge.</p> <p>E: Manually spin the impeller at the end of the suction tube to ensure the impeller spins freely.</p> <p>F: Wipe the battery terminals clean of any rust or other debris.</p> <p>G: Ensure the USB is fully in contact with the power supply.</p> <p>H: If the power supply is not 5V, 2A then attempt to power the pump with another source.</p>
Pump performance is low	<p>A: Batteries are depleted.</p> <p>B: Elevation of receiving tank is higher than supplying tank.</p>	<p>A: Replace the battery.</p> <p>B: Make sure that the receiving tank is not elevated above the supplying tank.</p>
Pump starts after pressing ON button but then stops unexpectedly	Filter of receiving tank may be blocked with foreign material.	Clean foreign material from the filter.
Pump immediately stops after pressing the ON button	A: Batteries are depleted.	A: Replace the battery.
Pump running, but no fuel delivery after pressing the ON button	The impeller is stuck or blocked by impurities.	Remove pump and clean impurities.
Pump stops before receptacle tank is full	<p>A: Batteries are depleted.</p> <p>B: Check for any blockages that may have occurred.</p> <p>C: The USB power supply is in poor contact or the power supply is insufficient.</p>	<p>A: Replace the batteries.</p> <p>B: Clear any blockages by the impeller and filter.</p> <p>C: Ensure that the USB power cable is fully connected to the power supply, and check the power supply.</p>